



HIGH-SPEED 4K x 8 DUAL-PORT STATIC SRAM

IDT7134SA/LA

Features

- ◆ **High-speed access**
 - Military: 25/35/45/55/70ns (max.)
 - Industrial: 25/35/55ns (max.)
 - Commercial: 20/25/35/45/55/70ns (max.)
- ◆ **Low-power operation**
 - IDT7134SA
 - Active: 700mW (typ.)
 - Standby: 5mW (typ.)
 - IDT7134LA
 - Active: 700mW (typ.)
 - Standby: 1mW (typ.)
- ◆ Fully asynchronous operation from either port
- ◆ Battery backup operation—2V data retention (LA only)
- ◆ TTL-compatible; single 5V ($\pm 10\%$) power supply
- ◆ Available in 48-pin DIP, LCC, Flatpack and 52-pin PLCC
- ◆ Military product compliant to MIL-PRF-38535 QML
- ◆ Industrial temperature range (-40°C to $+85^{\circ}\text{C}$) is available for selected speeds
- ◆ Green parts available, see ordering information

Functional Block Diagram

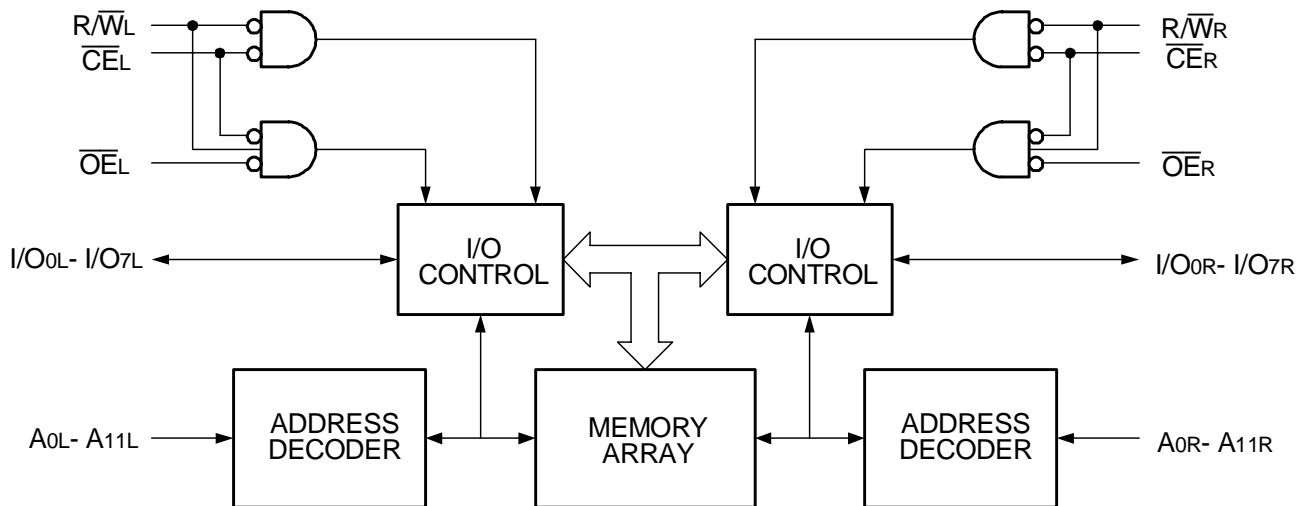

2720 drw 01

Description

The IDT7134 is a high-speed 4K x 8 Dual-Port Static RAM designed to be used in systems where on-chip hardware port arbitration is not needed. This part lends itself to those systems which cannot tolerate wait states or are designed to be able to externally arbitrate or withstand contention when both sides simultaneously access the same Dual-Port RAM location.

The IDT7134 provides two independent ports with separate control, address, and I/O pins that permit independent, asynchronous access for reads or writes to any location in memory. It is the user's responsibility to ensure data integrity when simultaneously accessing the same memory location from both ports. An automatic power down feature,

controlled by \overline{CE} , permits the on-chip circuitry of each port to enter a very low standby power mode.

Fabricated using IDT's CMOS high-performance technology, these Dual-Ports typically operate on only 700mW of power. Low-power (LA) versions offer battery backup data retention capability, with each port typically consuming 200 μ W from a 2V battery.

The IDT7134 is packaged on either a sidebrazed or plastic 48-pin DIP, 48-pin LCC, 52-pin PLCC and 48-pin Flatpack. Military grade product is manufactured in compliance with the latest revision of MIL-PRF-38535 QML, making it ideally suited to military temperature applications demanding the highest level of performance and reliability.

Pin Configurations^(1,2,3)

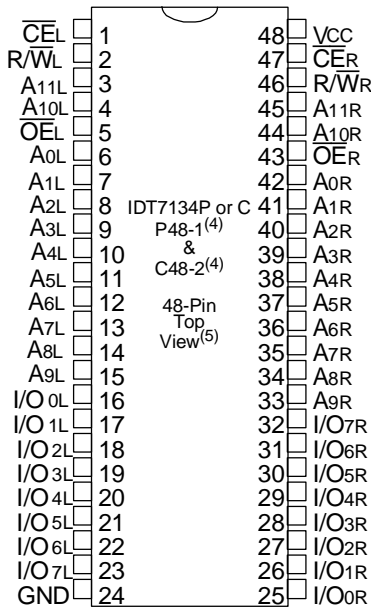

2720 drw 02

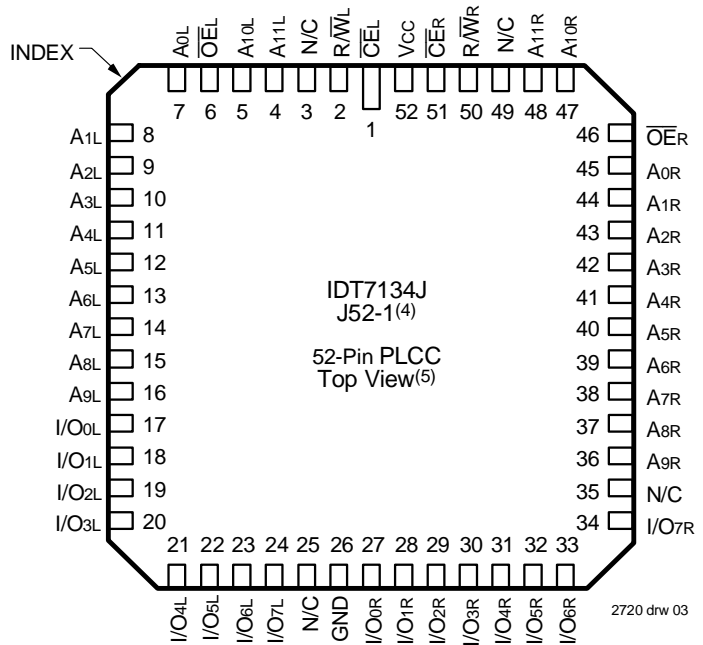

2720 drw 03

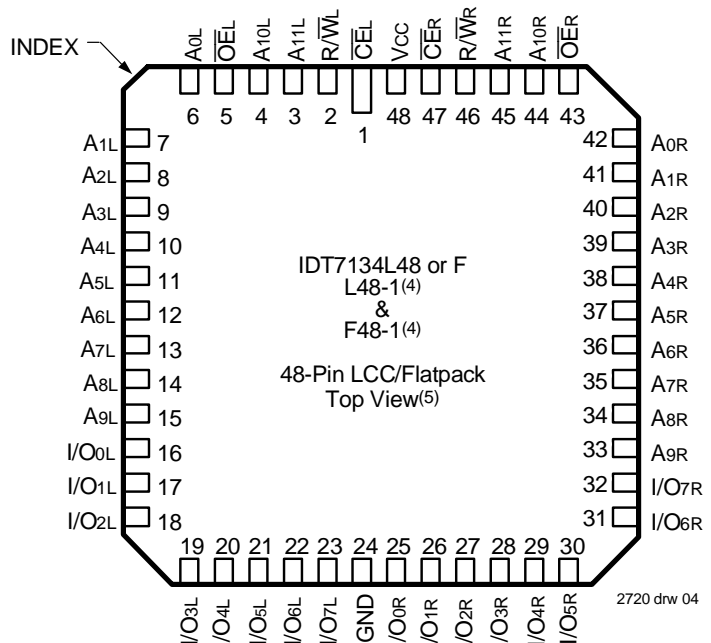

2720 drw 04

NOTES:

1. All Vcc pins must be connected to the power supply.
2. All GND pins must be connected to the ground supply.
3. P48-1 package body is approximately .55 in x 2.43 in x .18 in.
C48-2 package body is approximately .62 in x 2.43 in x .15 in.
J52-1 package body is approximately .75 in x .75 in x .17 in.
L48-1 package body is approximately .57 in x .57 in x .68 in.
F48-1 package body is approximately .75 in x .75 in x .11 in.
4. This package code is used to reference the package diagram.
5. This text does not indicate orientation of actual part-marking.

Absolute Maximum Ratings⁽¹⁾

Symbol	Rating	Commercial & Industrial	Military	Unit
V _{TERM} ⁽²⁾	Terminal Voltage with Respect to GND	-0.5 to +7.0	-0.5 to +7.0	V
T _{BIAS}	Temperature Under Bias	-55 to +125	-65 to +135	°C
T _{STG}	Storage Temperature	-65 to +150	-65 to +150	°C
P _T ⁽³⁾	Power Dissipation	1.5	1.5	W
I _{OUT}	DC Output Current	50	50	mA

2720 tbl 01

NOTES:

- Stresses greater than those listed under ABSOLUTE MAXIMUM RATINGS may cause permanent damage to the device. This is a stress rating only and functional operation of the device at these or any other conditions above those indicated in the operational sections of this specification is not implied. Exposure to absolute maximum rating conditions for extended periods may affect reliability.
- V_{TERM} must not exceed V_{CC} + 10% for more than 25% of the cycle time or 10 ns maximum, and is limited to ≤ 20mA for the period of V_{TERM} ≥ V_{CC} + 10%.
- V_{TERM} = 5.5V.

Capacitance⁽¹⁾ (T_A = +25°C, f = 1.0MHz)

Symbol	Parameter	Conditions ⁽²⁾	Max.	Unit
C _{IN}	Input Capacitance	V _{IN} = 3dV	11	pF
C _{OUT}	Output Capacitance	V _{OUT} = 3dV	11	pF

2720 tbl 02

NOTES:

- This parameter is determined by device characterization but is not production tested.
- 3dV references the interpolated capacitance when the input and output signals switch from 0V to 3V and from 3V to 0V.

Recommended Operating Temperature and Supply Voltage^(1,2)

Grade	Ambient Temperature	GND	V _{CC}
Military	-55°C to +125°C	0V	5.0V ± 10%
Commercial	0°C to +70°C	0V	5.0V ± 10%
Industrial	-40°C to +85°C	0V	5.0V ± 10%

2720 tbl 03

NOTES:

- This is the parameter T_A. This is the "instant on" case temperature.

Recommended DC Operating Conditions

Symbol	Parameter	Min.	Typ.	Max.	Unit
V _{CC}	Supply Voltage	4.5	5.0	5.5	V
GND	Ground	0	0	0	V
V _{IH}	Input High Voltage	2.2	—	6.0 ⁽²⁾	V
V _{IL}	Input Low Voltage	-0.5 ⁽¹⁾	—	0.8	V

2720 tbl 04

NOTES:

- V_{IL} (min.) ≥ -1.5V for pulse width less than 10ns.
- V_{TERM} must not exceed V_{CC} + 10%.

DC Electrical Characteristics Over the Operating Temperature and Supply Voltage Range (V_{CC} = 5V ± 10%)

Symbol	Parameter	Test Conditions	7134SA		7134LA		Unit
			Min.	Max.	Min.	Max.	
I _I	Input Leakage Current ⁽¹⁾	V _{CC} = 5.5V, V _{IN} = 0V to V _{CC}	—	10	—	5	μA
I _O	Output Leakage Current	\overline{CE} - V _{IH} , V _{OUT} = 0V to V _{CC}	—	10	—	5	μA
V _{OL}	Output Low Voltage	I _{OL} = 6mA	—	0.4	—	0.4	V
		I _{OL} = 8mA	—	0.5	—	0.5	V
V _{OH}	Output High Voltage	I _{OH} = -4mA	2.4	—	2.4	—	V

2720 tbl 05

NOTES:

- At V_{CC} ≤ 2.0V input leakages are undefined.

DC Electrical Characteristics Over the Operating Temperature and Supply Voltage Range^(1,2) ($V_{CC} = 5.0V \pm 10\%$)

Symbol	Parameter	Test Condition	Version		7134X20 Com'l Only		7134X25 Com'l, Ind & Military		7134X35 Com'l, Ind & Military		Unit
					Typ.	Max.	Typ.	Max.	Typ.	Max.	
I _{CC}	Dynamic Operating Current (Both Ports Active)	$\overline{CE} = V_{IL}$ Outputs Disabled $f = f_{MAX}^{(3)}$	COM'L	SA	170	280	160	280	150	260	mA
			LA	170	240	160	220	150	210		
I _{SB1}	Standby Current (Both Ports - TTL Level Inputs)	\overline{CE}_L and $\overline{CE}_R = V_{IH}$ $f = f_{MAX}^{(3)}$	COM'L	SA	25	100	25	80	25	75	mA
			LA	25	80	25	50	25	45		
I _{SB2}	Standby Current (One Port - TTL Level Inputs)	$\overline{CE}^A = V_{IL}$ and $\overline{CE}^B = V_{IH}$ Active Port Outputs Disabled, $f = f_{MAX}^{(3)}$	COM'L	SA	105	180	95	180	85	170	mA
			LA	105	150	95	140	85	130		
I _{SB3}	Full Standby Current (Both Ports - CMOS Level Inputs)	Both Ports \overline{CE}_L and $\overline{CE}_R \geq V_{CC} - 0.2V$ $V_{IN} \geq V_{CC} - 0.2V$ or $V_{IN} \leq 0.2V, f = 0^{(3)}$	COM'L	SA	1.0	15	1.0	15	1.0	15	mA
			LA	0.2	4.5	0.2	4.0	0.2	4.0		
I _{SB4}	Full Standby Current (One Port - CMOS Level Inputs)	One Port \overline{CE}^A or $\overline{CE}^B \geq V_{CC} - 0.2V$ $V_{IN} \geq V_{CC} - 0.2V$ or $V_{IN} \leq 0.2V$ Active Port Outputs Disabled, $f = f_{MAX}^{(3)}$	COM'L	SA	105	170	95	170	85	160	mA
			LA	105	130	95	120	85	110		
			MIL & IND	SA	—	—	160	310	150	300	
			LA	—	—	160	260	150	250		

2720 tbl 06a

Symbol	Parameter	Test Condition	Version		7134X45 Com'l & Military		7134X55 Com'l, Ind & Military		7134X70 Com'l & Military		Unit
					Typ.	Max.	Typ.	Max.	Typ.	Max.	
I _{CC}	Dynamic Operating Current (Both Ports Active)	$\overline{CE} = V_{IL}$ Outputs Disabled $f = f_{MAX}^{(3)}$	COM'L	SA	140	240	140	240	140	240	mA
			LA	140	200	140	200	140	200		
I _{SB1}	Standby Current (Both Ports - TTL Level Inputs)	\overline{CE}_L and $\overline{CE}_R = V_{IH}$ $f = f_{MAX}^{(3)}$	COM'L	SA	25	70	25	70	25	70	mA
			LA	25	40	25	40	25	40		
I _{SB2}	Standby Current (One Port - TTL Level Inputs)	$\overline{CE}^A = V_{IL}$ and $\overline{CE}^B = V_{IH}$ Active Port Outputs Disabled, $f = f_{MAX}^{(3)}$	COM'L	SA	75	160	75	160	75	160	mA
			LA	75	130	75	130	75	130		
I _{SB3}	Full Standby Current (Both Ports - CMOS Level Inputs)	Both Ports \overline{CE}_L and $\overline{CE}_R \geq V_{CC} - 0.2V$ $V_{IN} \geq V_{CC} - 0.2V$ or $V_{IN} \leq 0.2V, f = 0^{(3)}$	COM'L	SA	1.0	15	1.0	15	1.0	15	mA
			LA	0.2	4.0	0.2	4.0	0.2	4.0		
I _{SB4}	Full Standby Current (One Port - CMOS Level Inputs)	One Port \overline{CE}^A or $\overline{CE}^B \geq V_{CC} - 0.2V$ $V_{IN} \geq V_{CC} - 0.2V$ or $V_{IN} \leq 0.2V$ Active Port Outputs Disabled, $f = f_{MAX}^{(3)}$	COM'L	SA	75	150	75	150	75	150	mA
			LA	75	100	75	100	75	100		
			MIL & IND	SA	140	280	140	270	140	270	
			LA	140	240	140	220	140	220		

2720 tbl 06b

NOTES:

- 'X' in part number indicates power rating (SA or LA).
- $V_{CC} = 5V$, $T_A = +25^\circ C$ for typical, and parameters are not production tested.
- $f_{MAX} = 1/TC =$ All inputs cycling at $f = 1/TC$ (except Output Enable). $f = 0$ means no address or control lines change. Applies only to inputs at CMOS level standby I_{SB3}.

Data Retention Characteristics Over All Temperature Ranges

(LA Version Only) $V_{LC} = 0.2V$, $V_{HC} = V_{CC} - 0.2V$

Symbol	Parameter	Test Condition	Min.	Typ. ⁽¹⁾	Max.	Unit
V _{DR}	V _{CC} for Data Retention	V _{CC} = 2V	2.0	—	—	V
I _{CCDR}	Data Retention Current	$\overline{CE} \geq V_{HC}$ $V_{IN} \geq V_{HC}$ or $\leq V_{LC}$	MIL. & IND. —	100	4000	μA
			COM'L. —	100	1500	
t _{CDR} ⁽³⁾	Chip Deselect to Data Retention Time		0	—	—	ns
t _R ⁽³⁾	Operation Recovery Time		t _{RC} ⁽²⁾	—	—	ns

2720 tbl 07

NOTES:

- V_{CC} = 2V, T_A = +25°C, and are not production tested.
- t_{RC} = Read Cycle Time.
- This parameter is guaranteed by device characterization, but not production tested.

Data Retention Waveform

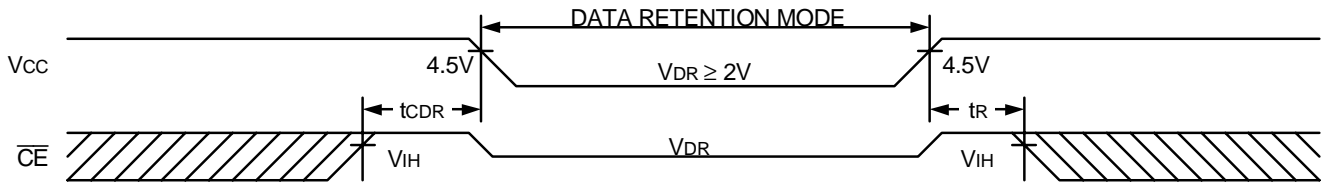

2720 drw 05

AC Test Conditions

Input Pulse Levels	GND to 3.0V
Input Rise/Fall Times	5ns
Input Timing Reference Levels	1.5V
Output Reference Levels	1.5V
Output Load	Figures 1 and 2

2720 tbl 08

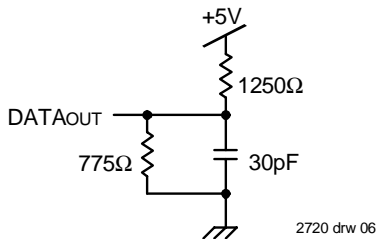

2720 drw 06

Figure 1. AC Output Test Load

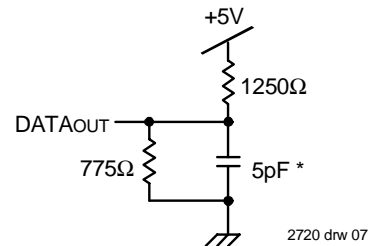

2720 drw 07

Figure 2. Output Test Load
(for t_{LZ}, t_{HZ}, t_{wz}, t_{ow})
*Including scope and jig

AC Electrical Characteristics Over the Operating Temperature and Supply Voltage⁽³⁾

Symbol	Parameter	7134X20 Com'l Only		7134X25 Com'l, Ind & Military		7134X35 Com'l, Ind & Military		Unit
		Min.	Max.	Min.	Max.	Min.	Max.	
READ CYCLE								
t _{RC}	Read Cycle Time	20	—	25	—	35	—	ns
t _{AA}	Address Access Time	—	20	—	25	—	35	ns
t _{ACE}	Chip Enable Access Time	—	20	—	25	—	35	ns
t _{AOE}	Output Enable Access Time	—	15	—	15	—	20	ns
t _{OH}	Output Hold from Address Change	0	—	0	—	0	—	ns
t _{LZ}	Output Low-Z Time ^(1,2)	0	—	0	—	0	—	ns
t _{HZ}	Output High-Z Time ^(1,2)	—	15	—	15	—	20	ns
t _{PU}	Chip Enable to Power Up Time ⁽²⁾	0	—	0	—	0	—	ns
t _{PD}	Chip Disable to Power Down Time ⁽²⁾	—	20	—	25	—	35	ns

2720 tbl 09a

Symbol	Parameter	7134X45 Com'l & Military		7134X55 Com'l, Ind & Military		7134X70 Com'l & Military		Unit
		Min.	Max.	Min.	Max.	Min.	Max.	
READ CYCLE								
t _{RC}	Read Cycle Time	45	—	55	—	70	—	ns
t _{AA}	Address Access Time	—	45	—	55	—	70	ns
t _{ACE}	Chip Enable Access Time	—	45	—	55	—	70	ns
t _{AOE}	Output Enable Access Time	—	25	—	30	—	40	ns
t _{OH}	Output Hold from Address Change	0	—	0	—	0	—	ns
t _{LZ}	Output Low-Z Time ^(1,2)	5	—	5	—	5	—	ns
t _{HZ}	Output High-Z Time ^(1,2)	—	20	—	25	—	30	ns
t _{PU}	Chip Enable to Power Up Time ⁽²⁾	0	—	0	—	0	—	ns
t _{PD}	Chip Disable to Power Down Time ⁽²⁾	—	45	—	50	—	50	ns

2720 tbl 09b

NOTES:

1. Transition is measured 0mV from Low or High-impedance voltage with the Output Test Load (Figure 2).
2. This parameter is guaranteed by device characterization, but is not production tested.
3. 'X' in part number indicates power rating (SA or LA).

AC Electrical Characteristics Over the Operating Temperature and Supply Voltage⁽⁵⁾

Symbol	Parameter	7134X20 Com'l Only		7134X25 Com'l, Ind & Military		7134X35 Com'l, Ind & Military		Unit
		Min.	Max.	Min.	Max.	Min.	Max.	
WRITE CYCLE								
t _{wc}	Write Cycle Time	20	—	25	—	35	—	ns
t _{ew}	Chip Enable to End-of-Write	15	—	20	—	30	—	ns
t _{aw}	Address Valid to End-of-Write	15	—	20	—	30	—	ns
t _{as}	Address Set-up Time	0	—	0	—	0	—	ns
t _{wp}	Write Pulse Width	15	—	20	—	25	—	ns
t _{wr}	Write Recovery Time	0	—	0	—	0	—	ns
t _{dw}	Data Valid to End-of-Write	15	—	15	—	20	—	ns
t _{hz}	Output High-Z Time ^(1,2)	—	15	—	15	—	20	ns
t _{dh}	Data Hold Time ⁽³⁾	0	—	0	—	3	—	ns
t _{wz}	Write Enable to Output in High-Z ^(1,2)	—	15	—	15	—	20	ns
t _{ow}	Output Active from End-of-Write ^(1,2,3)	3	—	3	—	3	—	ns
t _{wdd}	Write Pulse to Data Delay ⁽⁴⁾	—	40	—	50	—	60	ns
t _{ddd}	Write Data Valid to Read Data Delay ^(4,6)	—	30	—	30	—	35	ns

2720 tbl 10a

Symbol	Parameter	7134X45 Com'l & Military		7134X55 Com'l, Ind & Military		7134X70 Com'l & Military		Unit
		Min.	Max.	Min.	Max.	Min.	Max.	
WRITE CYCLE								
t _{wc}	Write Cycle Time	45	—	55	—	70	—	ns
t _{ew}	Chip Enable to End-of-Write	40	—	50	—	60	—	ns
t _{aw}	Address Valid to End-of-Write	40	—	50	—	60	—	ns
t _{as}	Address Set-up Time	0	—	0	—	0	—	ns
t _{wp}	Write Pulse Width	40	—	50	—	60	—	ns
t _{wr}	Write Recovery Time	0	—	0	—	0	—	ns
t _{dw}	Data Valid to End-of-Write	20	—	25	—	30	—	ns
t _{hz}	Output High-Z Time ^(1,2)	—	20	—	25	—	30	ns
t _{dh}	Data Hold Time ⁽³⁾	3	—	3	—	3	—	ns
t _{wz}	Write Enable to Output in High-Z ^(1,2)	—	20	—	25	—	30	ns
t _{ow}	Output Active from End-of-Write ^(1,2,3)	3	—	3	—	3	—	ns
t _{wdd}	Write Pulse to Data Delay ⁽⁴⁾	—	70	—	80	—	90	ns
t _{ddd}	Write Data Valid to Read Data Delay ^(4,6)	—	45	—	55	—	70	ns

2720 tbl 10b

NOTES:

1. Transition is measured 0mV from Low or High-impedance voltage with Output Test Load (Figure 2).
2. This parameter is guaranteed by device characterization, but is not production tested.
3. The specification for t_{dh} must be met by the device supplying write data to the RAM under all operating conditions. Although t_{dh} and t_{ow} values will vary over voltage and temperature, the actual t_{dh} will always be smaller than the actual t_{ow}.
4. Port-to-port delay through RAM cells from writing port to reading port, refer to "Timing Waveform of Write with Port-to-Port Read".
5. 'X' in part number indicates power rating (SA or LA).
6. t_{ddd} = 35ns for military temperature range.

Ordering Information

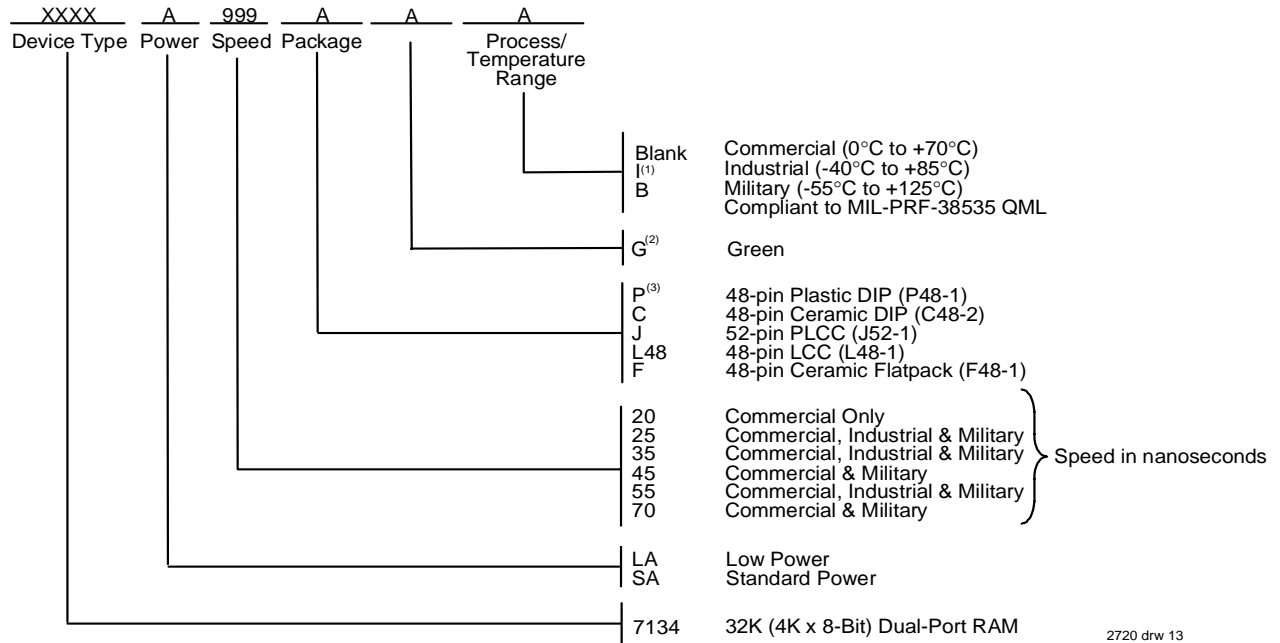

NOTES:

1. Contact your local sales office for industrial temp. range for other speeds, packages and powers.
2. Green parts available. For specific speeds, packages and powers contact your local sales office.
3. For "P", plastic DIP, when ordering green package the suffix is "PDG".

2720 drw 13